

POLYSTYRENE DOORS

SOLID MINERAL FIBER

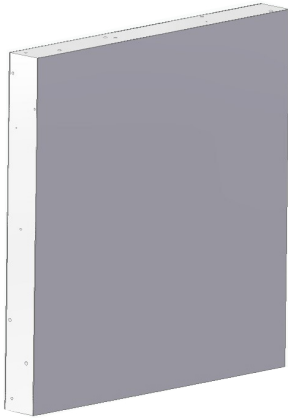

To ensure optimum thermal efficiency, a polystyrene slab is used, which is bonded to the inside of both face plates using a waterproof contact adhesive. This material not only provides thermal insulation, but also contributes to the structural strength of the assembly.

Suggested use:

Apartment, Condominiums, Dormitories, Motel/Hotel, Office, Urban renewal, Health care, Institutional, Mercantile, Public utility, Factory, Warehouse, Interior or Exterior.

DOOR DESIGNS

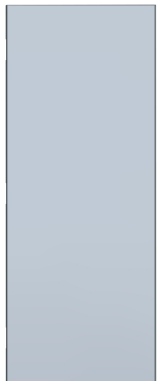

Flush

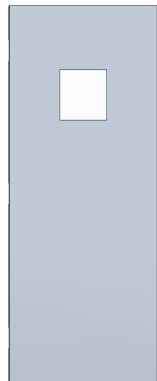

Glass Type 1

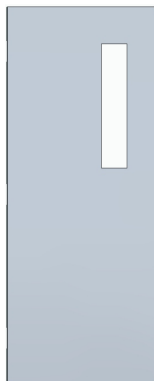

Glass Type 2

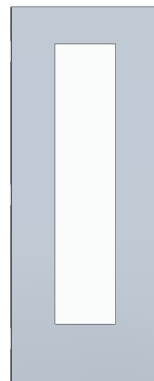

Glass Type 3

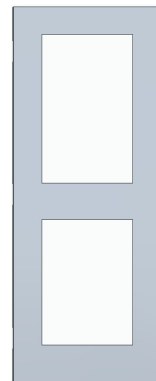

Glass Type 4

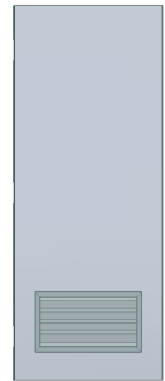

Louver

Steel doors with a thickness of 1-3/4 inches, with a honeycomb core, shall comply with the Steel Door Institute's guide specification, ANSI A250.8.

ANSI A250.8 establishes criteria to ensure that steel doors and frames meet acceptable safety and performance standards in a variety of applications. These standards may include factors such as strength, durability, and the ability to withstand specific environmental conditions. Additionally, these fire-rated doors with a honeycomb core can be manufactured in various gauges to suit specific strength and application requirements.

HARDWARE LOCATIONS

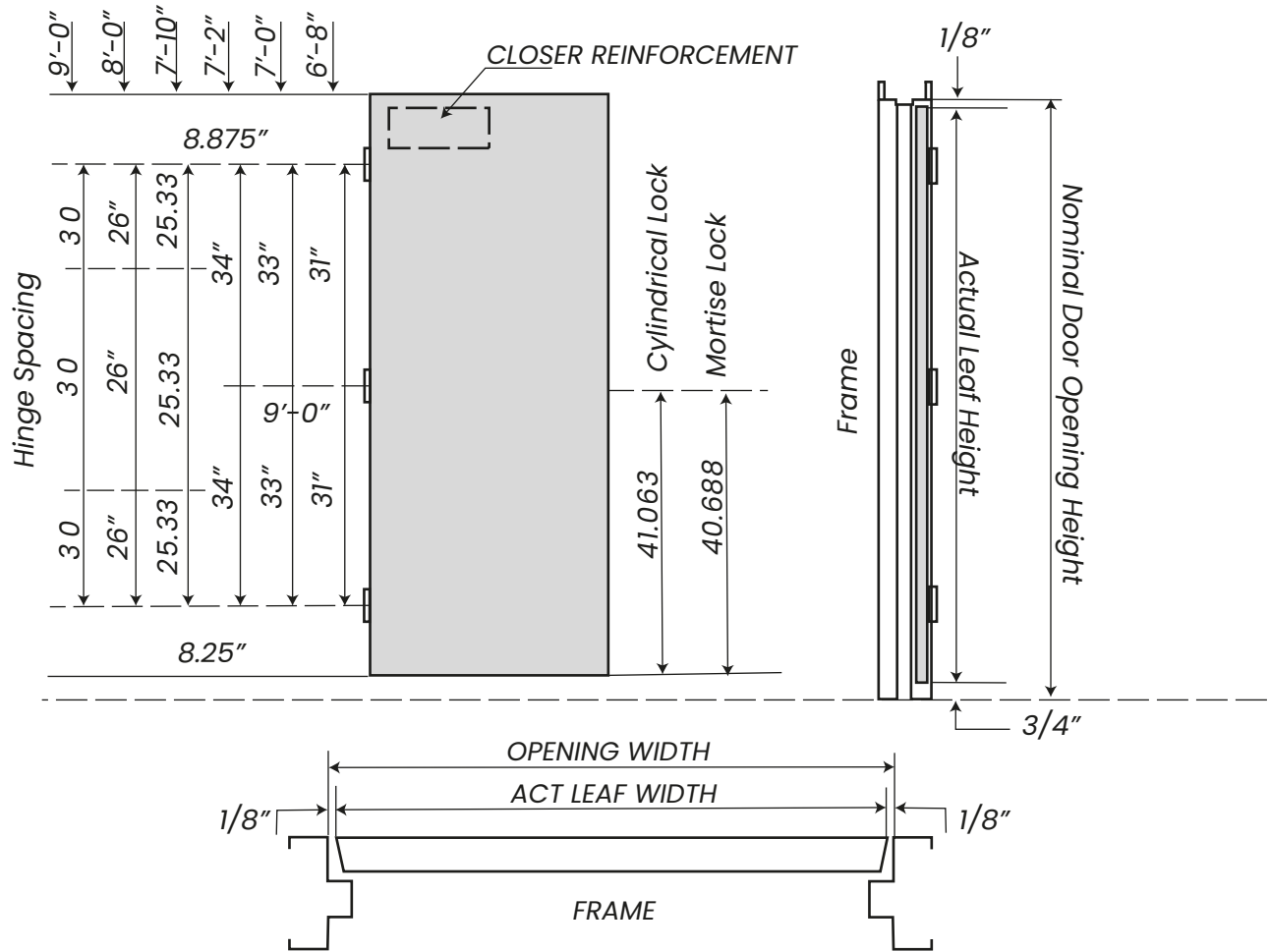

CHANNELS

16 GAGE STEEL
WELDED TO BOTH FACE SHEETS
INVERTED TOP AND BOTTOM

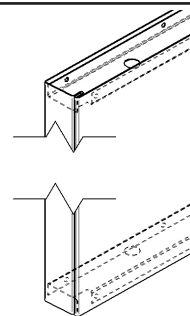

VERTICAL EDGES

VISIBLE SEAM
SPOT WELDS ALONG THE DOOR EDGE
ALLOWS THE INSTALLATION OF ANY TYPE OF
LOCKS

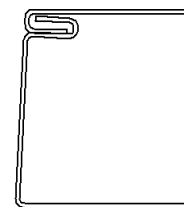

CLOSER REINFORCEMENT

14 GAGE STEEL
CHANNEL 20" LONG

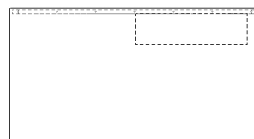

HINGE PREPARATION

4-1/2" HIGH
STANDARD OR HEAVY WEIGHT
FULL MORTISE
HINGE EDGE IS HANDED AND NOT BEVELED

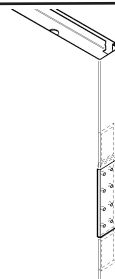

LOCK PREPARATION

GOV. 160/161
CYLINDRICAL TYPE
2-3/4" BACKSET

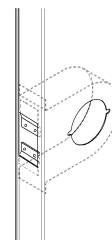

LOCK PREPARATION

GOV. 86, ANSI/BHMA A115.1
MORTISE TYPE
THE MORTISE REINFORCEMENT FITS ANY
MORTISE LOCK PREPARATION

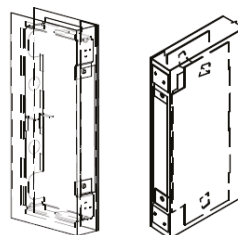

GLAZING TRIM

FOR ALL FIRE DOORS
3/8" WIDE GLAZING POCKET

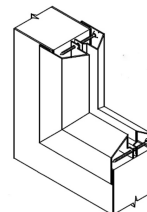

FIXED SLAT TYPE LOUVER

FOR 1-3/4" THICK DOOR
12"X24" FIRE RATED
24"X24" FIRE RATED

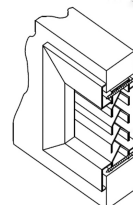

PRODUCT SPECIFICATIONS:

STANDAR SIZES

The 1-3/4-inch thick steel doors, manufactured by FORTIS DOORS, meet the Steel Door Institute's ANSI A250.8 standards.

WIDTH	HEIGHT
2' - 0"	6' - 8"
2' - 4"	
2' - 6"	
2' - 8"	
2' - 10"	
3' - 0"	
3' - 4"	
3' - 6"	
3' - 8"	
3' - 10"	
4' - 0"	8' - 0"

NOMINAL DOOR OPENING

Doors may have a fire resistance rating of up to three hours, except where glass is installed, which may be subject to limitations based on gauge, size, hardware, construction, etc.

The POLYSTIRENE DOORS series features visible joints and is constructed with front plates made of cold-rolled commercial-grade steel according to ASTM A1008. Additionally, the option of hot-dip galvanized or galvanized steel according to ASTM A924 and A653 is available.

A one-piece polystyrene board, conforming to ASTM C578 TYPE 1, is adhered to the inside of both faces with a waterproof contact adhesive.

Watertightness. The top and bottom edges of the door are closed with 16-gauge steel channels welded to both faceplates. Welded to both faceplates.

FIRE DOORS

UL CERTIFIED UP TO 3 HOURS
OF FIRE RESISTANCE

RATING: 1 HR, 1- 1/2 HR OR 3 HR
MAX. SIZE: 4'0" X 8'0" SINGLE

Regarding hardware, the edges of the hinge boxes are recessed for standard and heavy-duty 4-1/2-inch hinges, with 7-gauge steel reinforcements welded inside the door edge. Various locks can be installed depending on customer needs, with the option of internal plating for security locks, panic locks, fire-rated locks, and customer choice door closers.

For painting, the doors are supplied with a neutral-colored oven-cured primer coat, meeting ANSI A250.10 standards. A custom color option is available but may incur additional costs.

DOOR FACE SHEET	LEVEL	RECOMMENDED DOOR FRAME MATERIAL
20 GAGE STEEL	STANDARD DUTY	16 GAGE STEEL
18 GAGE STEEL	HEAVY DUTY	16 GAGE STEEL
16 GAGE STEEL	EXTRA HEAVY DUTY	16 OR 14 GAGE STEEL
14 GAGE STEEL	MAXIMUM DUTY	16 OR 12 GAGE STEEL