

# HONEYCOMB DOORS

DOORS WITH HONEYCOMB CORE, MADE OF GALVANIZED OR COLD ROLLED STEEL, WITH UP TO 180 MINUTES FIRE RESISTANCE UL CERTIFIED

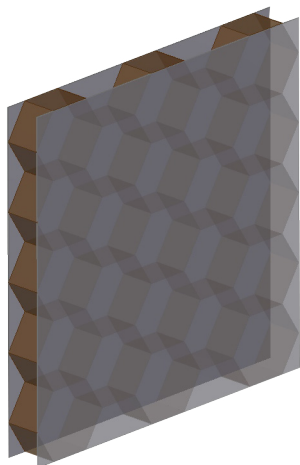

Certified by UL Solutions, with a HONEYCOMB core, rigid sheet adhered to both front sheets using waterproof contact adhesive.

**Suggested use:**

Fire-rated doors play a critical role in ensuring safety and protection in various building structures. Among the innovative solutions in fire door manufacturing, those with honeycomb cores stand out for their robustness, reliability, and versatility. These doors, crafted from galvanized or cold-rolled steel with thicknesses ranging from 20 to 18 gauge, offer enhanced fire resistance while maintaining structural integrity.

## DOOR DESIGNS



Flush

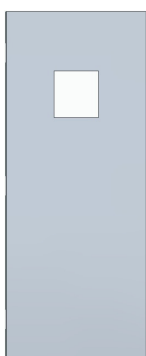

Glass Type 1



Glass Type 2

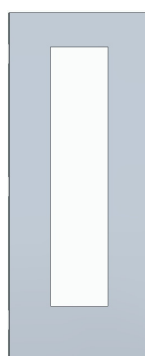

Glass Type 3

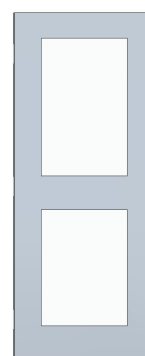

Glass Type 4



Louver

Steel doors with a thickness of 1-3/4 inches, with a honeycomb core, shall comply with the Steel Door Institute's guide specification, ANSI A250.8.

ANSI A250.8 establishes criteria to ensure that steel doors and frames meet acceptable safety and performance standards in a variety of applications. These standards may include factors such as strength, durability, and the ability to withstand specific environmental conditions. Additionally, these fire-rated doors with a honeycomb core can be manufactured in various gauges to suit specific strength and application requirements.

**HARDWARE LOCATIONS**

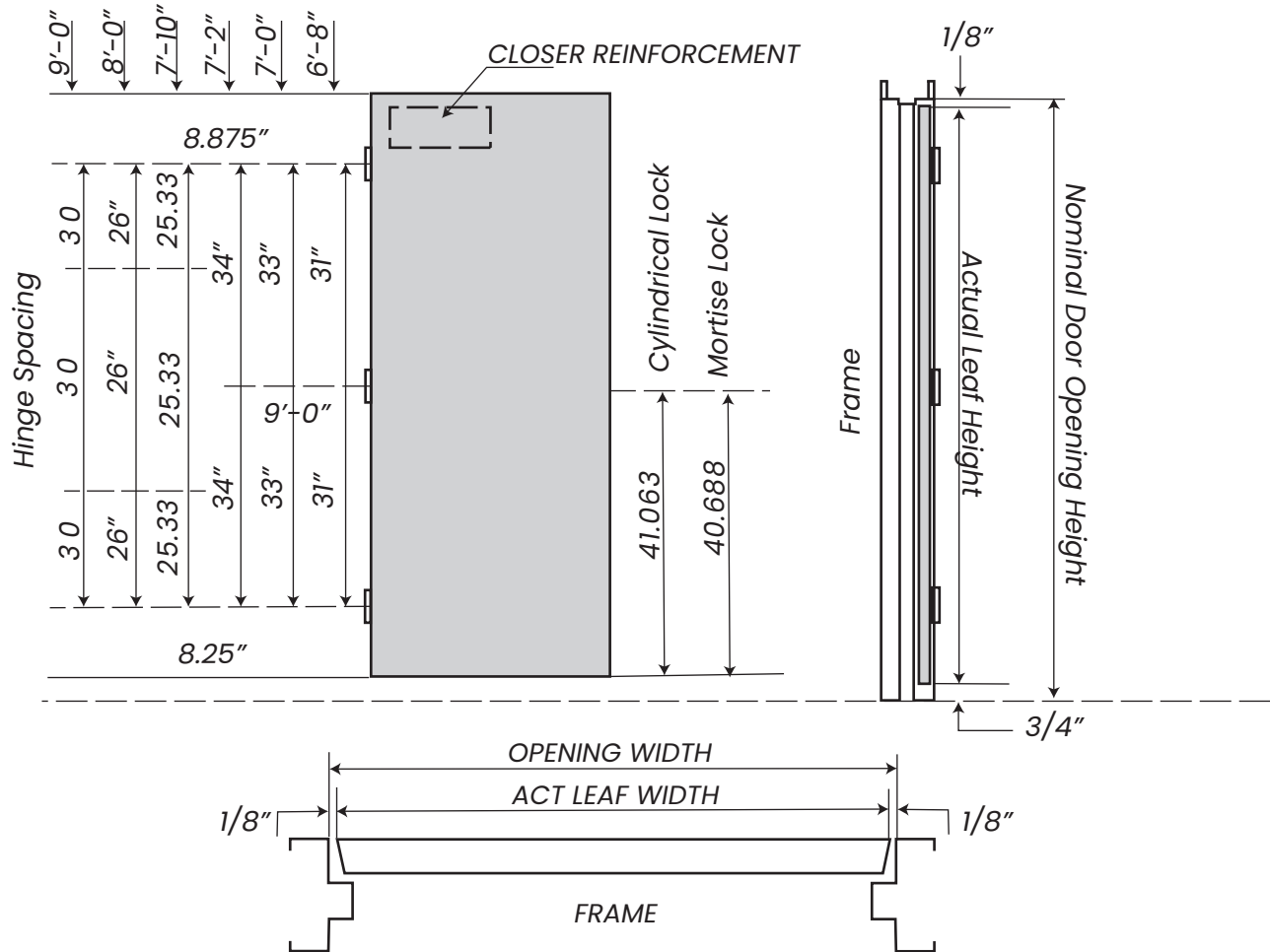

**CHANNELS**

16 GAGE STEEL  
WELDED TO BOTH FACE SHEETS  
INVERTED TOP AND BOTTOM

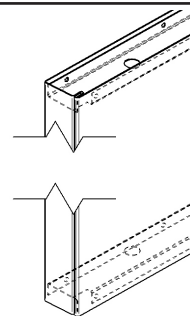

**VERTICAL EDGES**

VISIBLE SEAM  
SPOT WELDS ALONG THE DOOR EDGE  
ALLOWS THE INSTALLATION OF ANY TYPE OF  
LOCKS

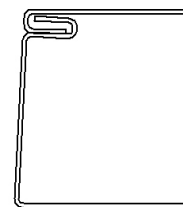

CLOSER REINFORCEMENT

14 GAGE STEEL  
CHANNEL 20" LONG

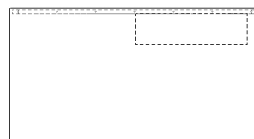

HINGE PREPARATION

4-1/2" HIGH  
STANDARD OR HEAVY WEIGHT  
FULL MORTISE  
HINGE EDGE IS HANDED AND NOT BEVELED

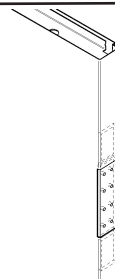

LOCK PREPARATION

GOV. 160/161  
CYLINDRICAL TYPE  
2-3/4" BACKSET

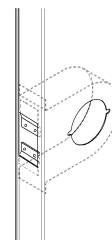

LOCK PREPARATION

GOV. 86, ANSI/BHMA A115.1  
MORTISE TYPE  
THE MORTISE REINFORCEMENT FITS ANY  
MORTISE LOCK PREPARATION

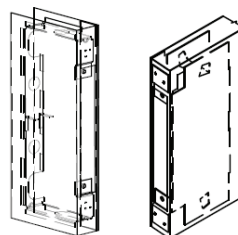

GLAZING TRIM

FOR ALL FIRE DOORS  
3/8" WIDE GLAZING POCKET

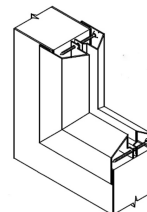

FIXED SLAT TYPE LOUVER

FOR 1-3/4" THICK DOOR  
12"X24" FIRE RATED  
24"X24" FIRE RATED

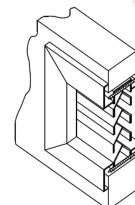

## PRODUCT SPECIFICATIONS:

### STANDAR SIZES

WIDTH	HEIGHT
2' - 0"	
2' - 4"	
2' - 6"	
2' - 8"	6' - 8"
2' - 10"	7' - 0"
3' - 0"	7' - 2"
3' - 4"	7' - 10"
3' - 6"	8' - 0"
3' - 8"	
3' - 10"	
4' - 0"	

NOMINAL DOOR OPENING

### FIRE DOORS

UL CERTIFIED UP TO 3 HOURS  
OF FIRE RESISTANCE

RATING: 1 HR, 1- 1/2 HR OR 3 HR  
MAX. SIZE: 4'0" X 8'0" SINGLE

The 1-3/4-inch thick steel doors, manufactured by FORTIS DOORS, meet the Steel Door Institute's ANSI A250.8 standards.

Doors may have a fire resistance rating of up to three hours, except where glass is installed, which may be subject to limitations based on gauge, size, hardware, construction, etc.

The HONEYCOMB DOORS series features visible joints and is constructed with front plates made of cold-rolled commercial-grade steel according to ASTM A1008. Additionally, the option of hot-dip galvanized or galvanized steel according to ASTM A924 and A653 is available.

These doors have visible joints joined by pressure between both faces and fixed with welding points. The kraft honeycomb core is firmly bonded to the front plates with contact adhesive. The top and bottom edges are sealed with 16-gauge steel channels.

Regarding hardware, the edges of the hinge boxes are recessed for standard and heavy-duty 4-1/2-inch hinges, with 7-gauge steel reinforcements welded inside the door edge. Various locks can be installed depending on customer needs, with the option of internal plating for security locks, panic locks, fire-rated locks, and customer choice door closers.

For painting, the doors are supplied with a neutral-colored oven-cured primer coat, meeting ANSI A250.10 standards. A custom color option is available but may incur additional costs.

DOOR FACE SHEET	LEVEL	RECOMMENDED DOOR FRAME MATERIAL
20 GAGE STEEL	STANDARD DUTY	16 GAGE STEEL
18 GAGE STEEL	HEAVY DUTY	16 GAGE STEEL
16 GAGE STEEL	EXTRA HEAVY DUTY	16 OR 14 GAGE STEEL
14 GAGE STEEL	MAXIMUM DUTY	16 OR 12 GAGE STEEL